

**Thank you for purchasing Dragon Lights**

Unlike most stock light systems, where lights can only be seen from the front and rear, multifunctional Dragon Lights mount on the end of the handle bar where it can be seen from almost any angle. This feature enhances safety for you and those around you by displaying your intentions to other drivers and pedestrians in almost all directions. The responsiveness of the signal and brake lights of the LED are much quicker than conventional lights. Dragon Lights also feature selectable safety light color. Displaying ultra-bright crystal lights with unconventional colors, not only make your vehicle more appealing, it also increases the awareness of your vehicle for the other drivers, which creates safer environment for everyone. Dragon Lights function as a **safety, brake and signal light** all combined in a single unit.

At Pleasantville distribution inc. we pride our selves in providing highest quality products in the market. **Your satisfaction is our goal.**  
**Patent Pending Pleasantville Distribution Inc.**

**WARRANTY**

This warranty covers any defects in materials or workmanship for 90 days from the date of original purchase. This warranty does not cover damage caused by misuse or use other than as intended and described in this product instruction manual, or loss or damage to any parts. If the purchased product has any defects in material or workmanship follow the return instruction below.

**No Hassle 30 Day Return/Exchange Policy**

All returns must be post marked within 30 days from the original date of Purchase. The Return Authorization does not imply a replacement or refund, but only that we will inspect the merchandise based on your claim. Returns must be sent freight prepaid and insured by you. Original shipping and handling charges are not refundable. A photo copy of your invoice showing the invoice number must accompany your return along with a written explanation and a contact phone number where we may be able to reach you. It is the responsibility of the customer/installer to verify the correctness of size and application of the parts before installation. The factory retains the right to replace the item with a similar item of equal or greater value provided returned item is no longer available. The returned item must be in same condition as when it was purchased and complete in parts in the original retail package. If returned item does not meet the above conditions mentioned, we reserve the right refuse the package and or replace the returned item.





**Return address:**

Pleasantville Dist. Inc.  
 P.O Box 0341  
 Greenvale, NY 11548

**Disclaimer**

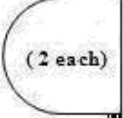
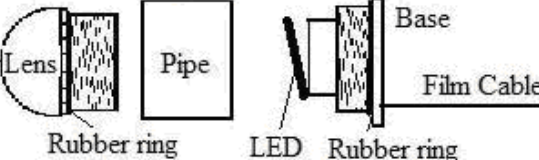
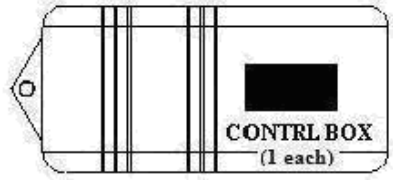
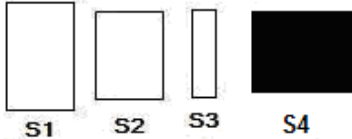
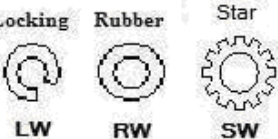
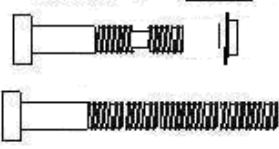
Pleasantville distribution inc. shall not be liable for any consequential or incidental damages whatsoever. Pleasantville distribution inc. liability is limited to replacement of the item(s) purchased. Unless otherwise note, all items are currently NOT DOT approved and are only for off road or show use. Use of these products may be limited, regulated, or prohibited in your state, please check with all applicable motor vehicle code and laws before installing. We are in working process to get Dragon Lights DOT approved. Contact :516-669-1538 Fax:516-801-6899

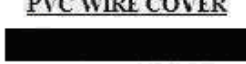
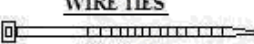
**PARTS LIST**

<p><b>SLIDER</b> (2 each)</p> 	<p><b>SLIDER PARTS</b></p> 		 <p><b>CONTRL BOX</b> (1 each)</p>	<p><b>SPACER (2 each)</b></p>  <p>S1 S2 S3 S4</p>	
<p><b>WASHERS (2 each)</b></p>  <p>LW RW SW</p>		<p><b>BOLTS &amp; NUTS</b></p>  <p>(2 each)</p>	<p><b>VELCRO</b></p>  <p>(1 each)</p>	<p><b>SHRINK TUBE</b></p>  <p><b>PVC WIRE COVER</b></p>  <p><b>WIRE TIES</b></p> 	<p><b>RUBBER EXPANDERS</b></p>  <p>R1 R2 for 7/8 inch for 1 inch</p>

## Step 1. Testing the Lights

First thing you should do is to test the lights to make sure the lights are in proper working order.

1. Open the Dragonlights box and pull out just the control box and the light end caps.
2. Open the control box by using small Philips screw driver and remove four screws on the bottom of the control box.
3. Temporary connect the film cable to control box for testing. **See Illustration T1.**

**(NEVER CONNECT OR DISCONNECT THE LIGHTS WITH THE POWER ON, THIS CAN DAMAGE THE CONTROL BOX!!!)**  
Push the brown tab back in after you have inserted the film cable to lock in place.

**Illustration T1.**

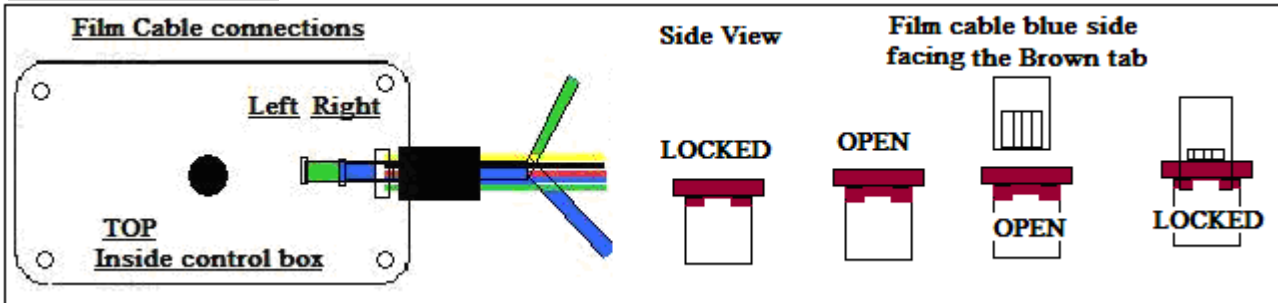

Open the connector by pulling on the brown tab about 1/8 inch away from the board. Slide the end of the film cable straight into the connector with blue side of the film cable facing the brown tab the silver side should be facing the control button.





4. Test the lights by connecting the wires to the battery. **See Illustration Below.**

<p style="text-align: center;"><b>Running light test</b></p>	<p>Connect the yellow wire directly to the battery (+) terminal and connect the black wire to the ground (-) terminal or to the body of the bike. Now press and release the button repeatedly and see 7 different color. and one rotation mode then off mode.</p>
<p style="text-align: center;"><b>Brake light test</b></p>	<p>Set the running color to Blue or Green. With the Yellow and Black wire still connected, connect the red wire to the battery (+) Terminal. Both lights should turn RED.</p>
<p style="text-align: center;"><b>Right signal test</b></p>	<p>With the yellow and Black wire still connected, connect the Green wire to the battery (+) terminal. Right light should turn Amber.</p>
<p style="text-align: center;"><b>Left signal test</b></p>	<p>With the yellow and Black wire still connected, connect the Blue wire to the battery (+) terminal. Left light should turn Amber.</p>

5. Now disconnect all wires and disconnect the film cable by opening the brown tab and pulling it out..

**If the lights fail the test do not proceed. Call the service number at the bottom of this manual.**

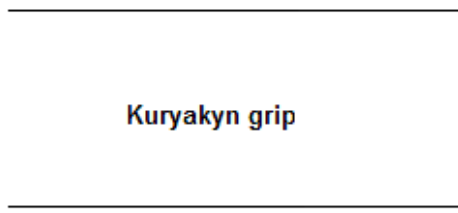
## STEP 2. Preparing the grip.

G5	 <p><b>Kuryakyn Grips</b></p>	<p>Remove both grip.</p> <ol style="list-style-type: none"> <li>1. Remove the endcap.</li> <li>2. Drill 1 1/8" hole using 1 1/8" Unibit making the grip hollow</li> </ol>	
 <p>Kuryakyn grip</p>		 <p>1 1/8" Step drill unibit</p>	

## STEP 3 Preparing the film cable on the light

Unroll and straighten out the film cable : hold the film cable at the light end with one hand and pinch the film Cable with you thumb and point finger of the other hand and run your fingers through the film cable towards the other end. Repeat until the film cable is straight and flat. Repeat for both lights.

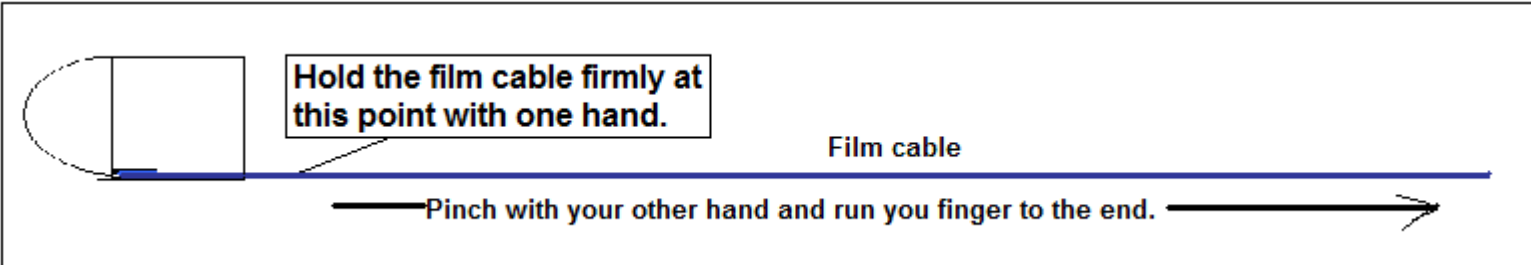

Hold the film cable firmly at this point with one hand.

Film cable

Pinch with your other hand and run you finger to the end.

## STEP 4 Prepare your handlebar and Assembling the light parts

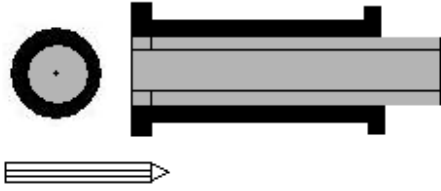
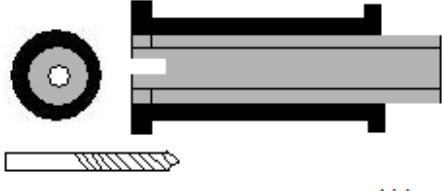
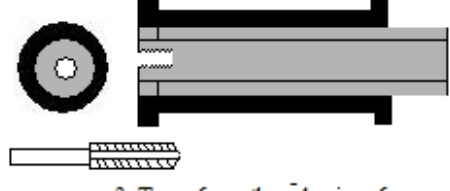

Select and assemble the base that best fits your handlebar. See below.

Solid or Blocked with weight handlebar type H4 following the instruction below

 <p>1. Mark the center of the handle bar end, using a metal punch.</p>	 <p>2. Drill a hole using 13/64" carbide metal bit about 1" deep.</p>	 <p>3. Tap a 6mm thread using 6mm threading tool and lube oil.</p>
--	---	---

Now use 6mm Threaded Handlebar setup

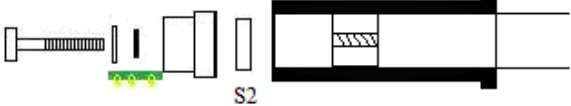
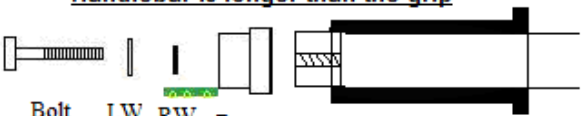
## 6mm Threaded Handlebars

<p><u>Grip and the handlebar is flush end.</u></p>  <p>Bolt LW RW Base S1</p>	<p><u>Grip is longer than the handlebar</u></p>  <p>S2</p>
<p><u>Handlebar is longer than the grip</u></p>  <p>Bolt LW RW Base</p>	<p><u>Cut this point</u></p>  <p>If you need to shorten the bolt screw the nut pass the cut point then cut the bolt.</p>

## 8mm Threaded Handlebars

### For Kawasaki and other Cruisers with blocked end with 8mm threaded hole

Call our office and 8mm bolts.

Enlarge the hole in the base of the light and the metal spacers with 11/32 or 3/8 drill bit so the 8mm bolt will fit through the hole. Use the 8mm bolt to mount on to the handle bar. See illustration below

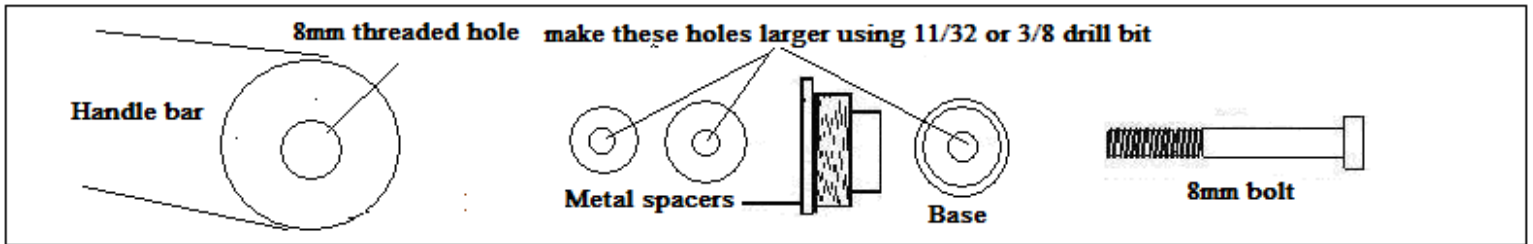

Enlarge the holes in the spacers only the ones you need.

## STEP 5 Light wiring instruction

### Left Side installation:

1. Open the small rolls of shrink tube, measure against the film cable and cut it 2 inch shorter than the cable.
2. Insert the film cable into the shrink tube and use heat gun or a lighter to shrink it down to half size.

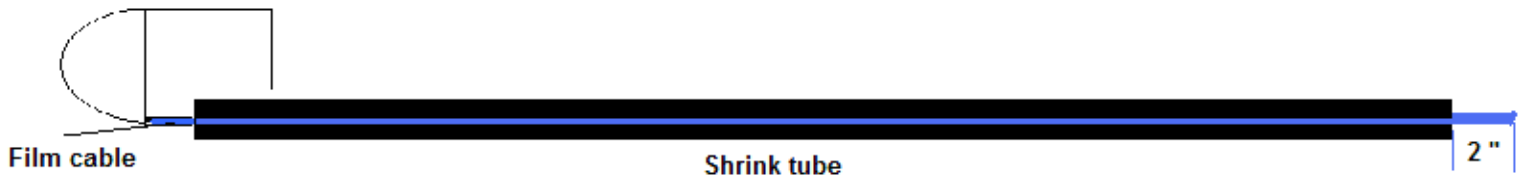

3. Remove the grip from the handle bar and insert the film cable and the slider into the grip and while holding the film cable with one hand and the grip and the slider with the other hand, carefully slide the grip back on the handle bar. (Make sure the film cable is laying flat on the bottom inside of the grip).

**Option 1. IMPORTANT!!!** after you remove the grip, that you clean and wet the part of the handle bar and inside of the grip. Use a little water to make it slide on smoothly.

**(DO NOT TWIST THE GRIP WHILE SLIDING BACK ON, JUST WIGGLE A BIT.)**

The left side grip will move a bit because of the water but it will secure when the water dries.

**Option 2.** Dry inside the grip and the bar and use glue as a lubricant and slide it back on the handlebar. (do not use instant setting glue you might not have enough time to insert the grip fully back on.)

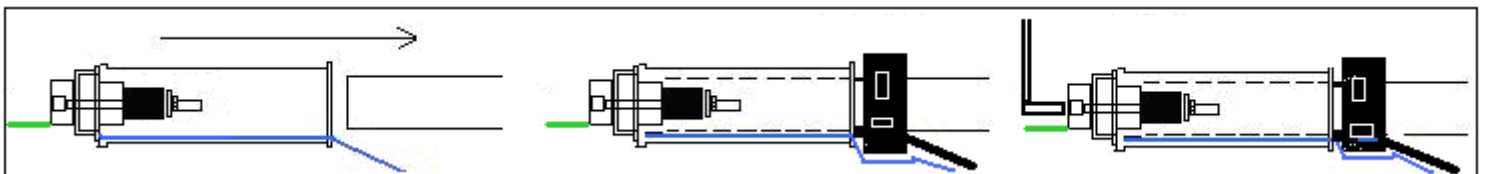

## **STEP 6**   **Right side installation** – **Removing the grip**

1. Unscrew and Open ignition control unit. Unscrew and detach the brake level.  
If your throttle cable disconnects and reconnects easily, then disconnect the throttle cable and remove the grip.

If the throttle cable is really hard to disconnect, try removing the grip without disconnection the throttle cable. Detach the handlebar from the bike and move it over to the left side so you can get enough slack of the wires. Now slide out the grip and the ignition control unit together with the throttle cable still attached. In most cases it is easier to work with the brake level detached from the handle bar.

2. Clean the handlebar and the inside of the throttle pipe and spray a little lubricant such as WD40 to the inside of the plastic throttle body for smoother action.
3. Slide the film cable inside the plastic throttle pipe. t of the throttle body and while holding one side of the film cable slide the grip back on to the handle bar.
4. After you fully inserted the grip and the light, use Allen key to secure the light while hold the base with one hand or use a channel lock or insert a flat screw driver into the open slot on the base to prevent the base from turning.  
**(DO NOT GRIP ON THE THREADED PART OF THE BASE WITH CHANNEL LOCK)**
5. Pull on the film cable lightly to make sure there is no extra slack on the film cable and it is laying straight and flat inside the throttle plastic. While holding the film cable, wrap electric tape over the film cable and the handle bar as shown above. This part is **VERY IMPORTANT** because the film must be secured so it does not move with the throttle. **See below**

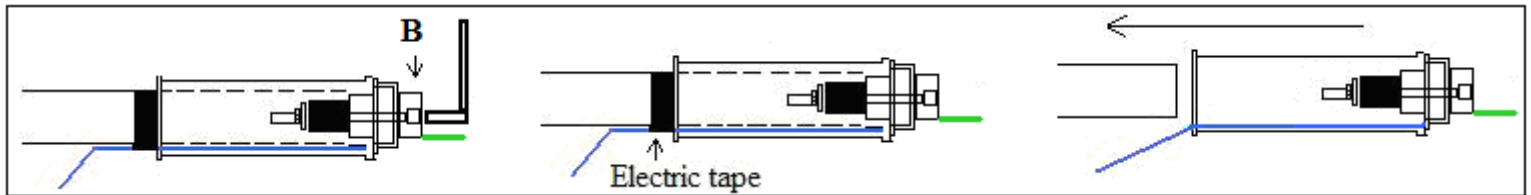

**This case is very rare but it does happens. One in few hundread. See below.**

\*\*\* After replacing the grip with film cable inside and taping it off, turn the throttle few times to make sure it returns smoothly. If throttle sticks you might need to sand out the inside of the throttle plastic pipe using stone grinder with extension and a Drill. Film cable is only .2 mm thick so you just need to sand out a bit. \*\*\*

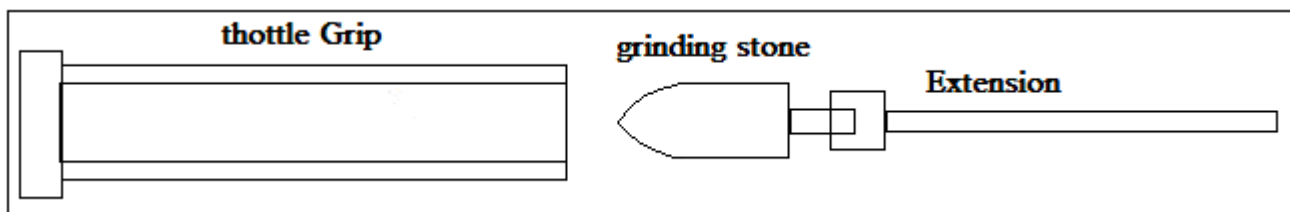

6. Cover the exposed film cable with shrink tube and shrink the tube using heat gun or lighter. (leave 2 inch exposed end)
7. Run the shrink wrapped cable along the existing ignition wire harness. Reattach the ignition control unit.  
When reattaching the ignition control make sure the film cable is not pinch where it can be cut or damaged.
8. Water proof the light by applying silicone in the holes on the base.

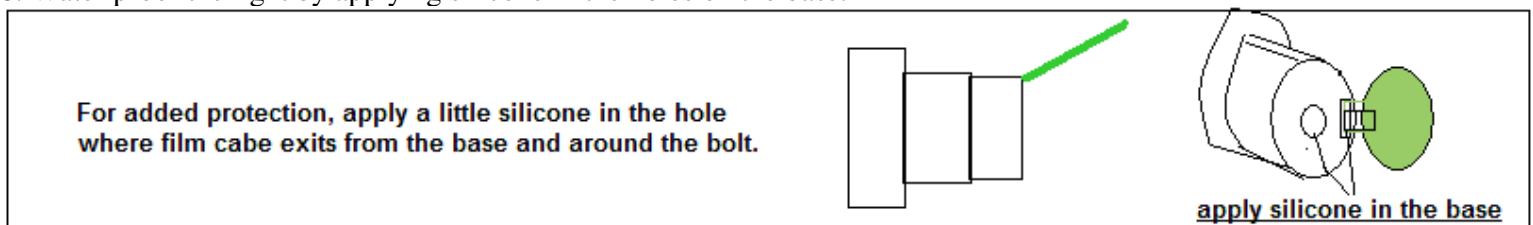

9. Replace the pipe and the lens. (make sure the base does not turn while screwing the pipe and the lens.

## **STEP 7**

### **Connecting the control box wires to your vehicle light harness**

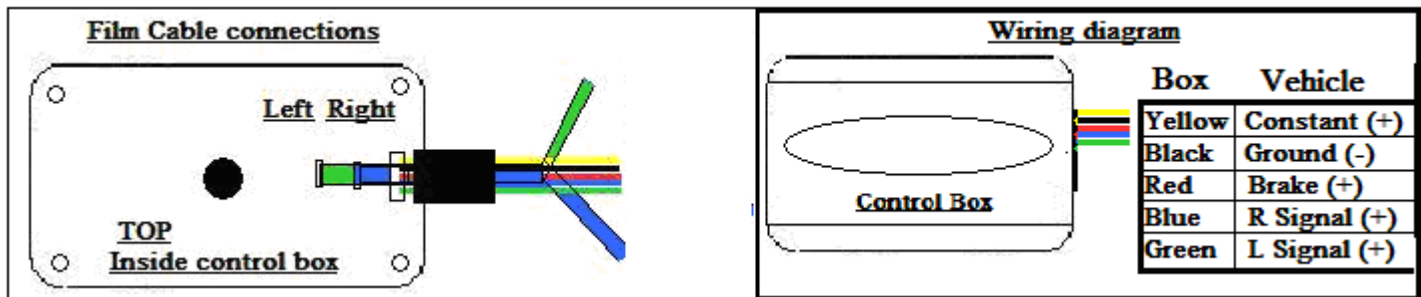

If you are familiar with the location of your vehicle's light wire harness, tap it from there.

If you are not familiar with it, then follow the instruction below:

1. All wires except for Brake can be found inside of the wire harness that comes out from the left light control unit.
2. Cut open the left signal control wire harness about 2" long along the harness and expose the wires inside.
3. Using the 12Volt circuit tester, connect the clip end to the grounded body part of the bike.

#### 4. Locating the wires needed.

##### A. Finding 12volt constant (+) :

A1. Turn the key to on position and start probing the wires by piercing the wire cover with the sharp pointy end of the tester.

A2. When the light on the tester turns on steady keep it connected, now turn on and off the hi beam, horn and the left and the right signal switch on and off, one at a time and see if the light on the tester goes off. If the light goes out go to next wire until you find the wire where light on the tester stays on steady.

**Color of the constant wire is usually Brown or Yellow with Red line.**

B. **Ground (-):** Connect the BLACK Ground wire from the control box directly to the any bolt on the bike.

C. **Left signal (+):** Repeat step A1, then turn the **Left signal** on. Now look for the test light to start blinking.

Once you find a wire that causes the test light to blink, keep it connected and turn the signal switch on the bike to off position and make sure the light turns off. Now turn the switch to the **Right signal** and make sure the test light does not start blinking. **On most bikes the Left turn signal wire color is Black, Grey or Orange.**

D. **Right signal (+):** Repeat step A1, but this time, turn the Right signal on. Make sure the test light does not blink when **left signal** is on. On most bikes the **Right turn signal wire color is Blue or Lite Green.**

\* There are wires that constantly blink independent of signal control, and there are wires that blink when signal is on left or right. These are not the wires you need. \*

\*\* The colors of the wires may be different, depending on the make and the model and the year of your bike.\*\*

E. **Brake:** There are two wires connected to the brake level on the right side of your handlebar.

Unplug the connection and turn the key to the on position then test each wire. One of the two wire should be constant 12vt and the other should be switched. Connect the tip of the tester to the one that is not a constant 12vt. Apply the foot brake and check to make sure the light goes on only when brake is applied.

5. Find the location where you want to mount the control box and measure the length of the wires you need to make The connection to the wires you just found. Now cut the wires to the length you need and cover with shrink tube.

Choose a location for the control box around the front dash board, where wires has enough slack when full turn is made. There are optional extension wire set available.

## 6. Making the connections.

**Important:** Wires are to be piggy backed. So NEVER cut the wires from the vehicle. See illustration below.

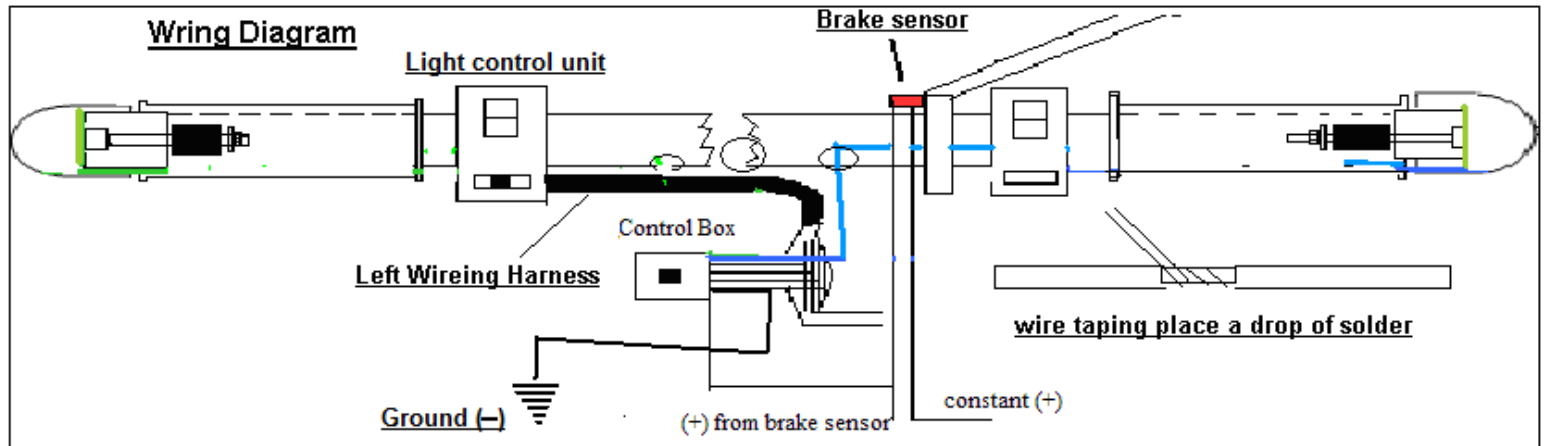

7. Tape up all wires and harness tightly with electric tape and wire ties.

## **STEP 8**      **Connecting the film cable to the control box.**

1. Open the control box by using small Philips driver and remove 4 small screws on the bottom.
2. Slide the film cables through the protective wire tube with blue tip side facing down. (**you can not see the blue side**)
3. Slide the Right side film cable first then slide the left side film cable on top of the right side cable.
4. Open the connector attached to the control box and insert the film cable to the corresponding sides.  
**(NEVER EVER CONNECT OR DISCONNECT THE LIGHTS WITH THE POWER ON, IT CAN DAMAGE THE CONTROL BOX !!! IF SHORT OCCURS WHILE CONNECTING)**

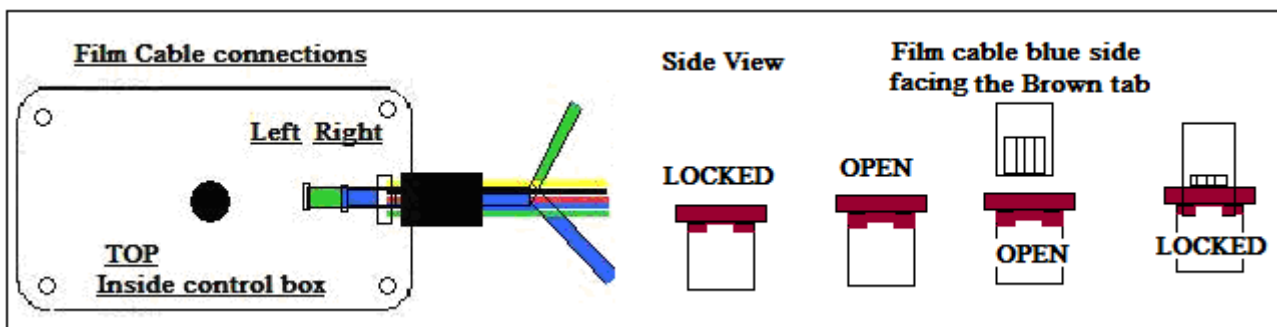

5. Close the box and secure the cover with four screws from the bottom.
6. Attach the other half of the Velcro to the back of the control box and attach the box to the other Velcro.
7. Make sure all wires have enough slack. At full turn, the wires should not pull. Secure the wires with wire ties.

### **Using the control Box function**

**Press and release the button to change the color of the light, enter rotation mode and turn off running light.  
Press and hold 3 seconds to turn on the flash mode (two flashes) and turn off the flash mode (one flash).**